

---

# User Manual

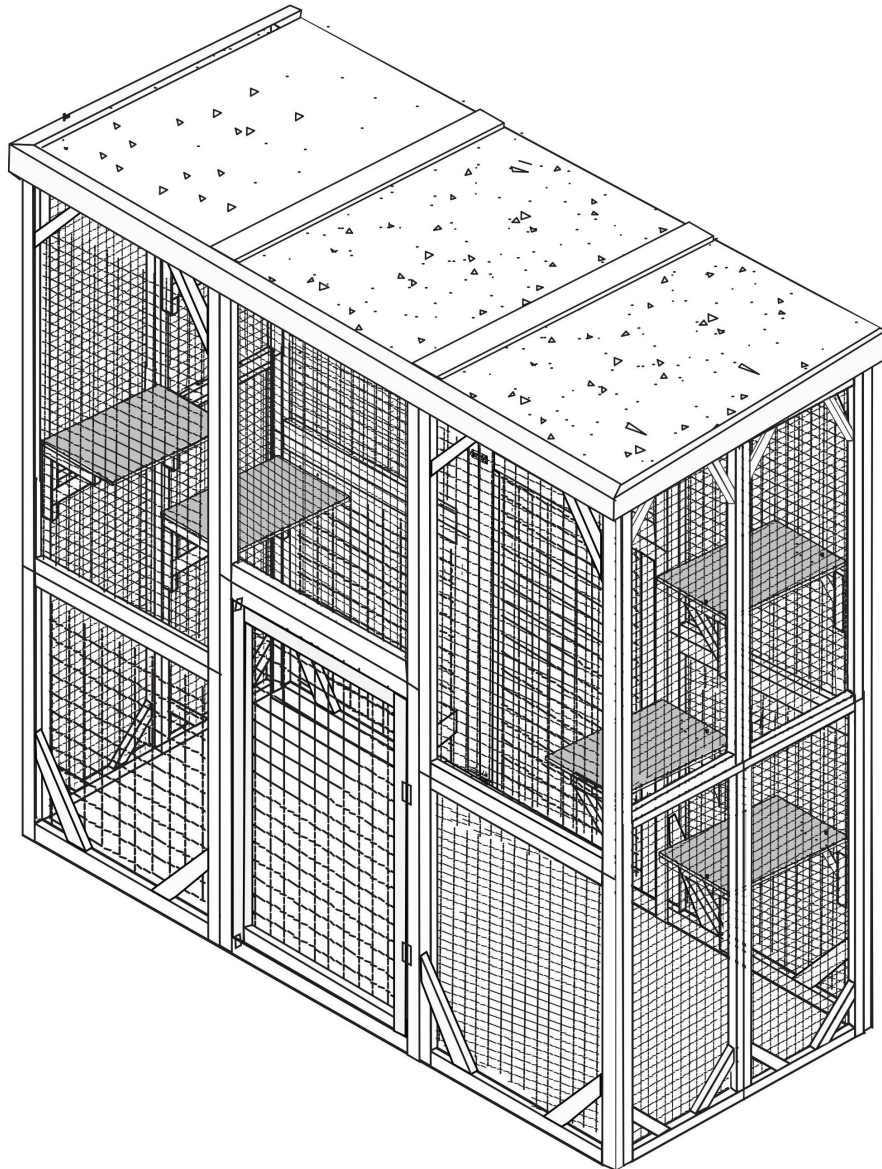

---

## **Dear Customer,**

Thank you for your purchase.

When you receive the product, please make sure that all the parts are intact.

Then please browse the entire installation manual before assembly.

If problems occur unsatisfactorily as follows:

**a. The outer box is damaged.**

**b. The product is damaged / bent / cracked while you open the box.**

**c. The parts / accessories / assembly tools are missing.**

**d. The product is hard to assemble.**

**e. The instructions are not clear and can not be referred to.**

**f. The product has functional problems.**

**g. Other aspects that you are not satisfied with.**

# You need

**① Tools required**

A Phillips head screwdriver is required for the assembly of this product. (not included)

Power tools should not be used to assemble this product.

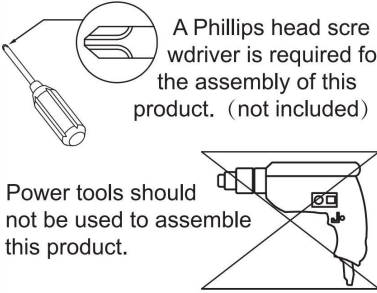

**② 2 person is needed**









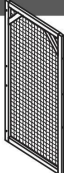
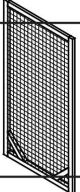
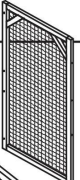
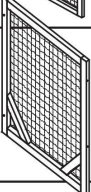
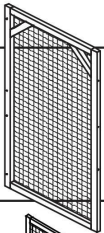
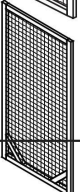
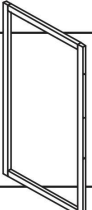

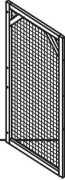
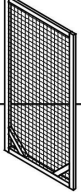

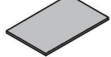

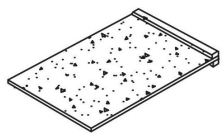
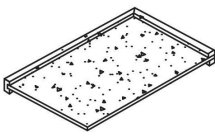
**③ Take 30 minutes**

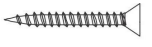

Technical Specifications	
Material	wood
Colour	Gray

Pos.	Description		Quantity	Box Number
1	Upper side part, left		2	-22
2	Lower side part, left		2	-22
3	Upper front and back parts, middle		2	-12
4	Lower front and back parts, left/right		4	-12
5	Upper front and back parts, left/right		4	-22
6	Lower back part, middle		1	-12
7	Lower-front door, middle		1	-12

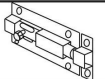
Pos.	Description		Quantity	Box number
8	Upper side part, right		2	-22
9	Lower side part, right		2	-22
10	Front door, middle		1	-12
11	Platforms		6	-22
12	Brackets for platforms		12	-22
13	Roof parts		1	-22
14	Roof parts for left/right		2	-12
15	Roof parts		2	-22
16	Roof parts		2	-22
17	Guide book		1	-22

Pos.	Description		Size	Quantity	Box number
A	Countersunk screw		M4 × 50 mm	56+1(gift)	-22
B	Countersunk screw		M4 × 35 mm	56+1(gift)	-22
C	Countersunk screw		M3 × 20 mm	40+1(gift)	-22
D	Countersunk screw		M3 × 12 mm	20+1(gift)	-22
E	Bolt			2	-22
F	Hinge			2	-22

# PRODUCT ASSEMBLY

 Check the package contents before getting started !

## STEP 1

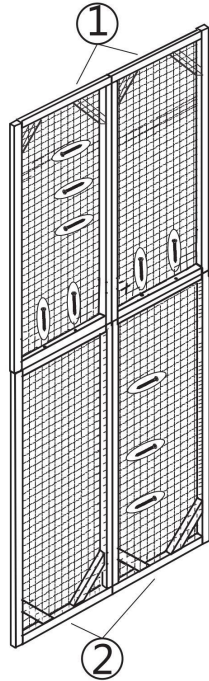
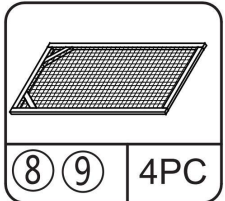
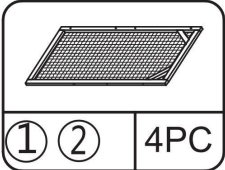
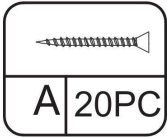

20 × **(A)**

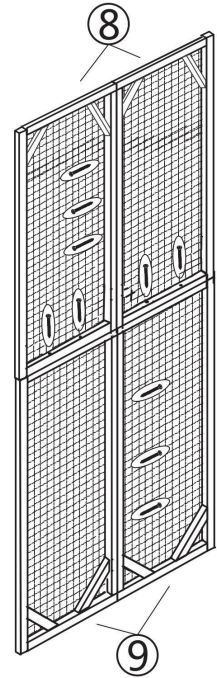

## STEP 2

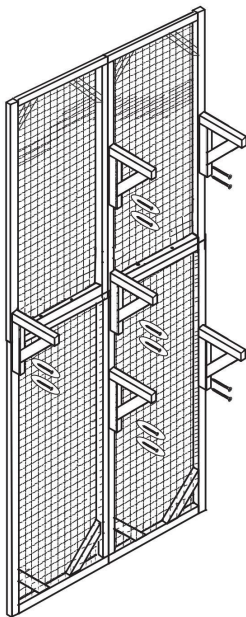
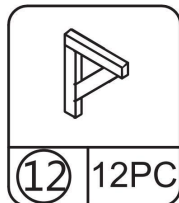
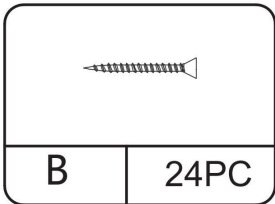

24 × **(B)**

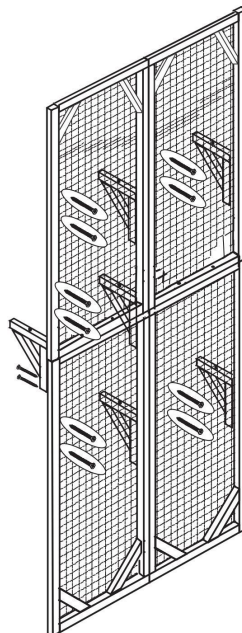

# PRODUCT ASSEMBLY

## STEP 3

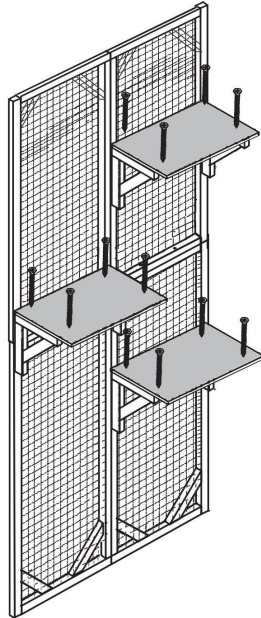
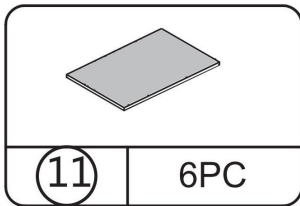
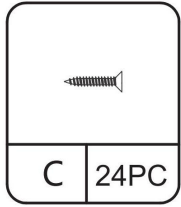

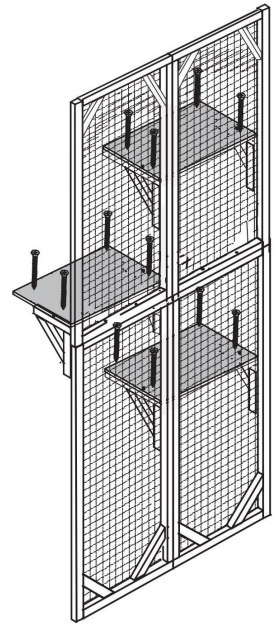

24 × C

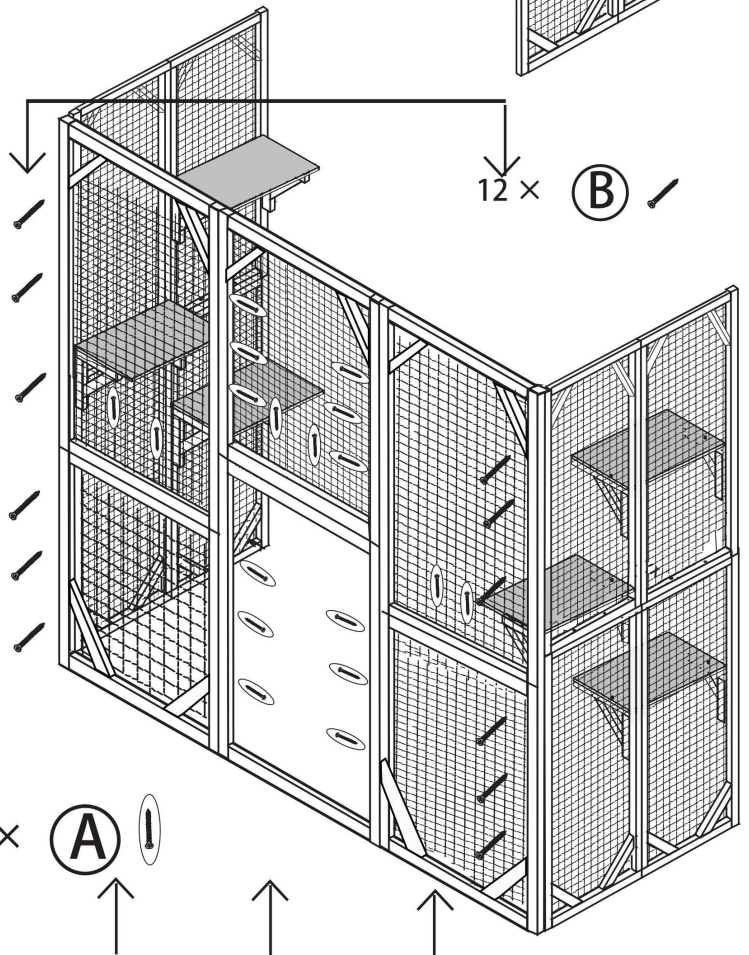
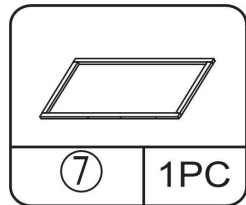
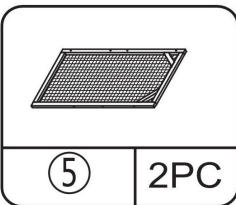
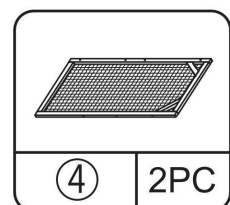
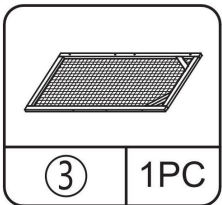
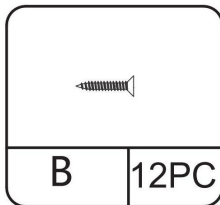
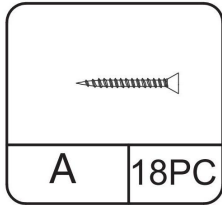

## STEP 4

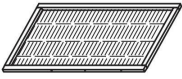

# STEP 5

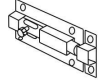
			
⑩ 1PC	D 20PC	F 2PC	E 2PC

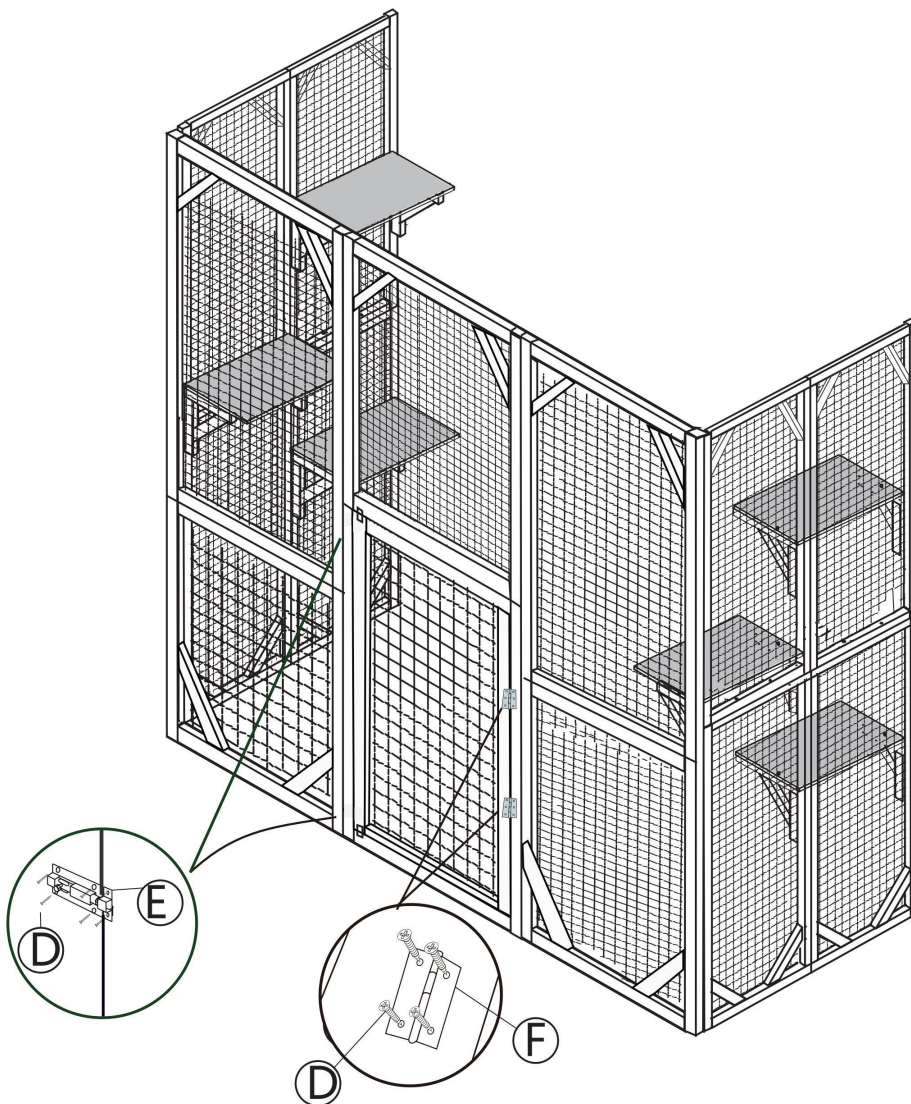

PRODUCT ASSEMBLY

STEP 6

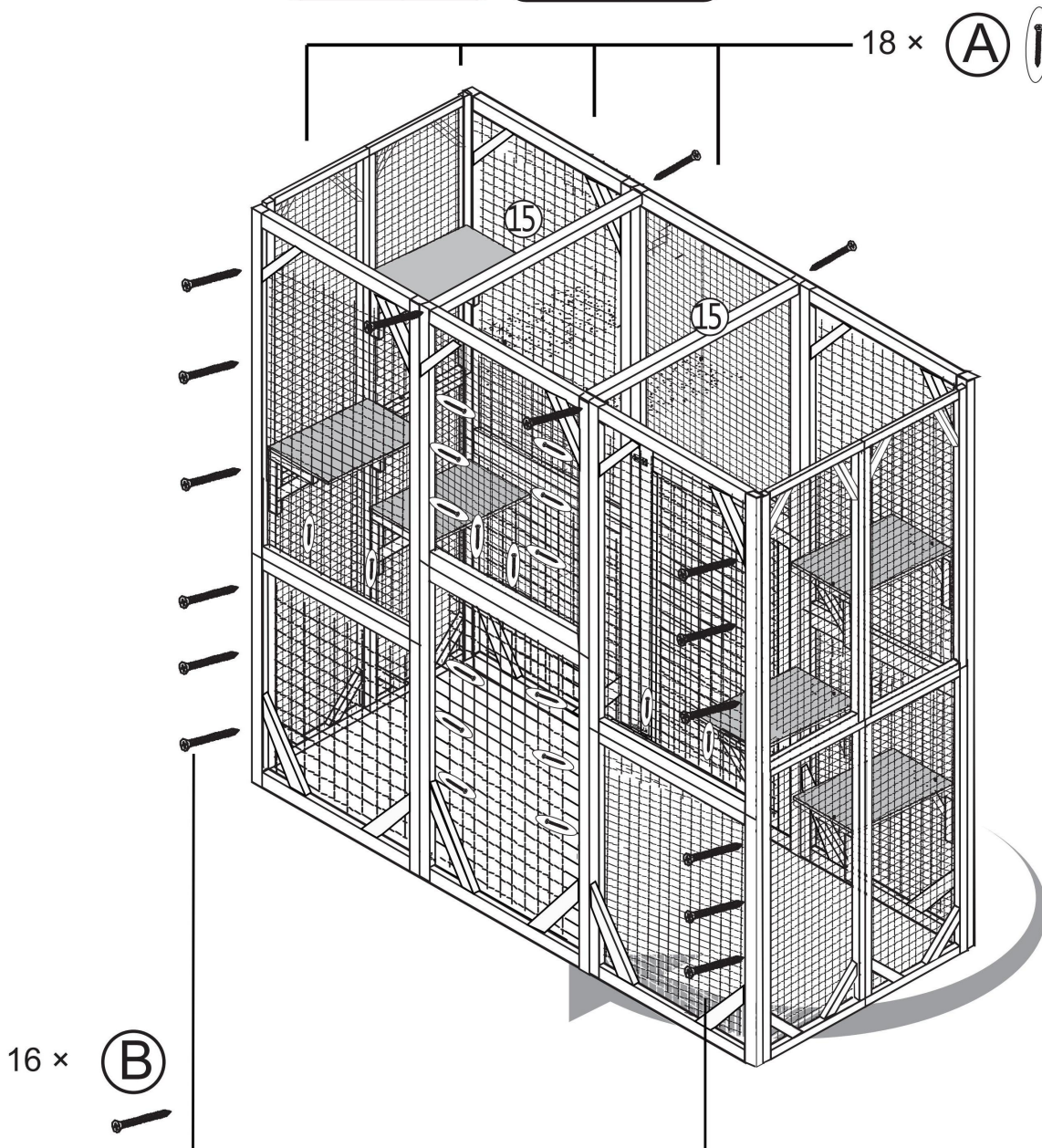
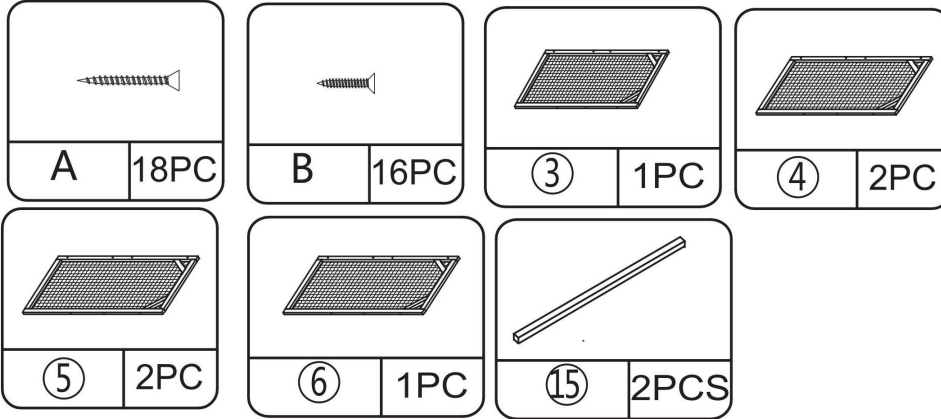



PRODUCT ASSEMBLY

STEP 7

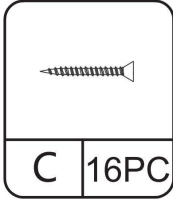
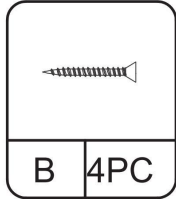
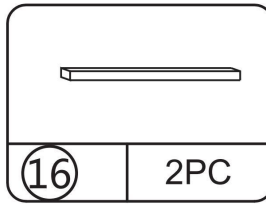
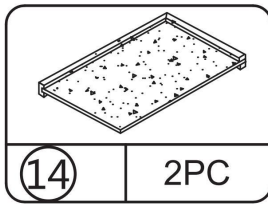
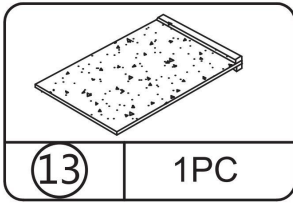

4 × (B) 

